

S\_03

SKYY

SIMPLE. SMART. SPA.

Technical sheet

MADE IN ITALY

## S\_03

Full electric multifunctional SPA massage bed | Wood-metal structure

*Hergo System:*  
anti-stress  
ergonomic  
face hole

sleek  
aluminium  
control panel

comfortable  
space for  
operator's legs

one-slot storage  
with push-pull  
opening

height, backrest and  
legrest silent electric  
adjustments

touch effect  
with 3D textured  
finishes

17 cm  
*Cloud* mattress  
including  
Memory Foam

design selection:  
squared or rounded  
plateau / mattress

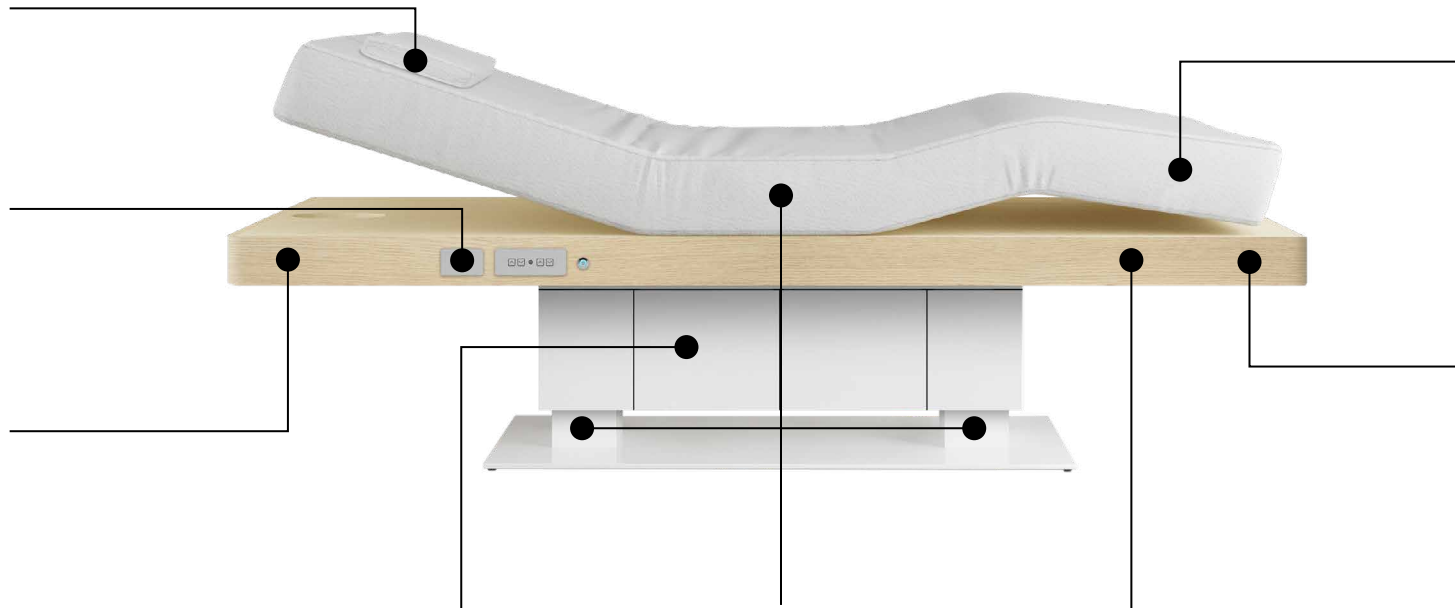

S\_03 (SQUARED PLATEAU)

S\_03R (ROUNDED PLATEAU)

Dimensions in mm (inches)

PLAN

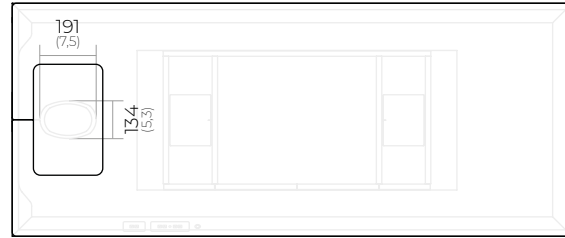

PLAN

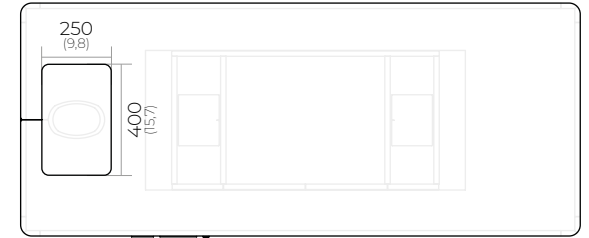

BED UP

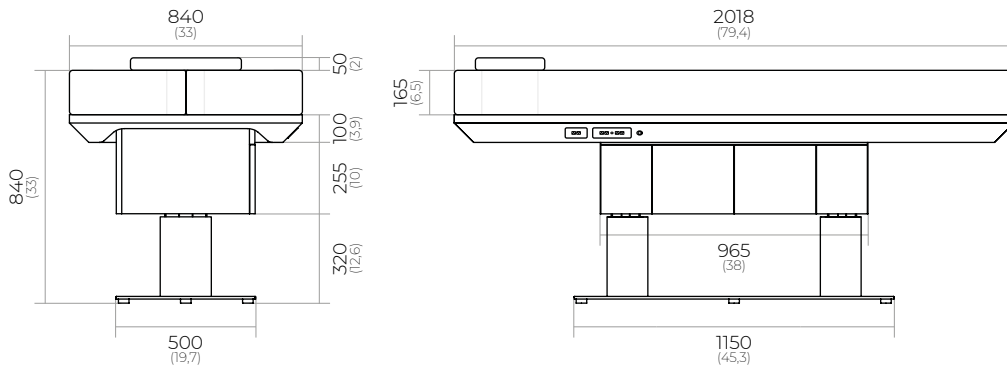

BED UP

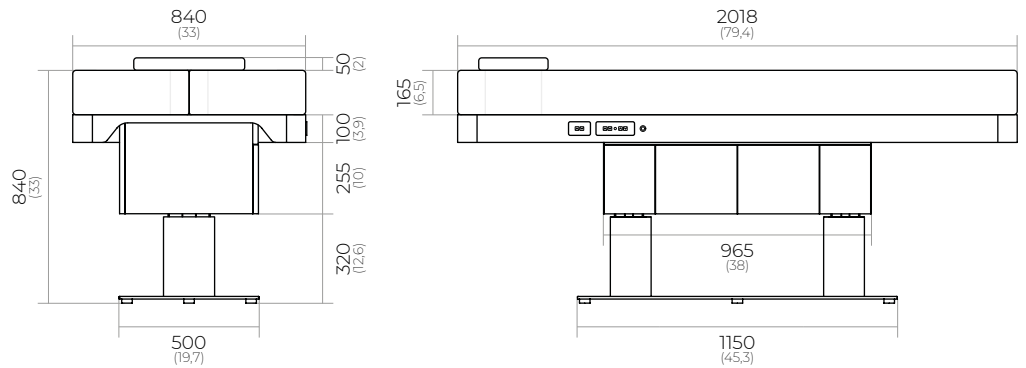

BED DOWN

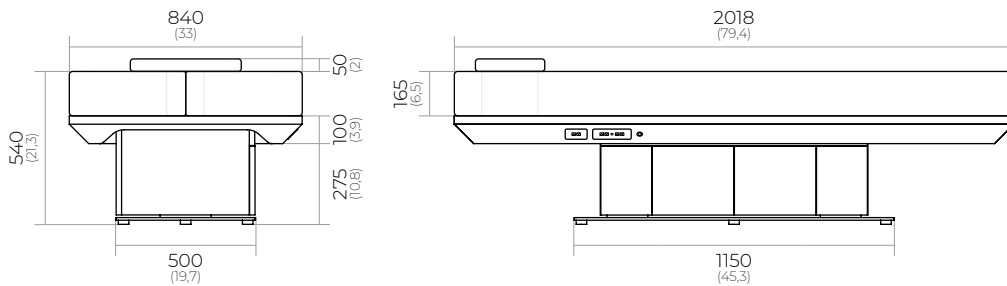

BED DOWN

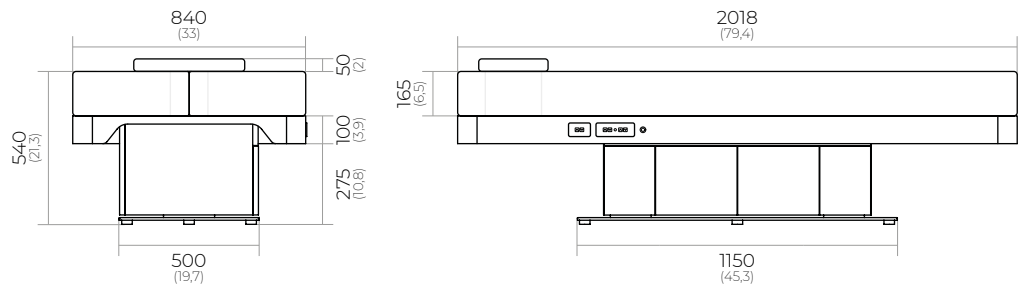

NOTES

The specifications listed are subject to change without notice to ensure the highest quality and performance. They do not replace in any case the signature for approval on technical drawings.

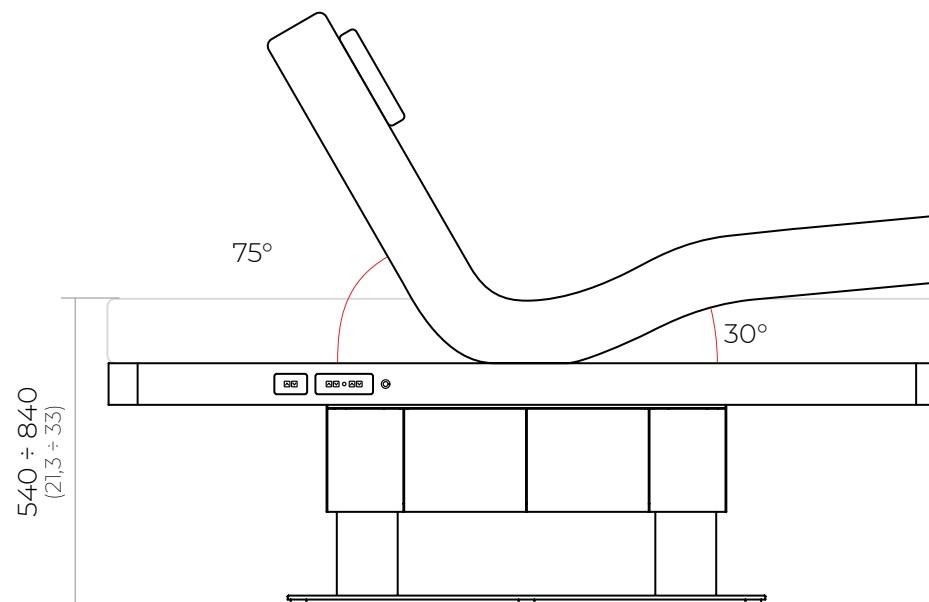

Backrest adjustment	75°
Legrest adjustment	30°
Stroke of the motors	300 mm (11,8 inches)
Lift capacity	400 kg (882 lbs)
Weight	175 kg (386 lbs)

## NOTES

The bed adjustments are controlled by the aluminium panel located on the side of the plateau.

ONE-SLOT STORAGE

PUSH-PULL OPENING

SOCKET INCLUDED



Length	570 (22,5)
Width	460 (18,1)
Height	230 (9,1)
Volume	60 L

H  
W L  
mm (inches)

Power supply cable comes out from under the base and can be directed through either foot. Depending on the installation, the cable should be connected to an external socket or a floor outlet.

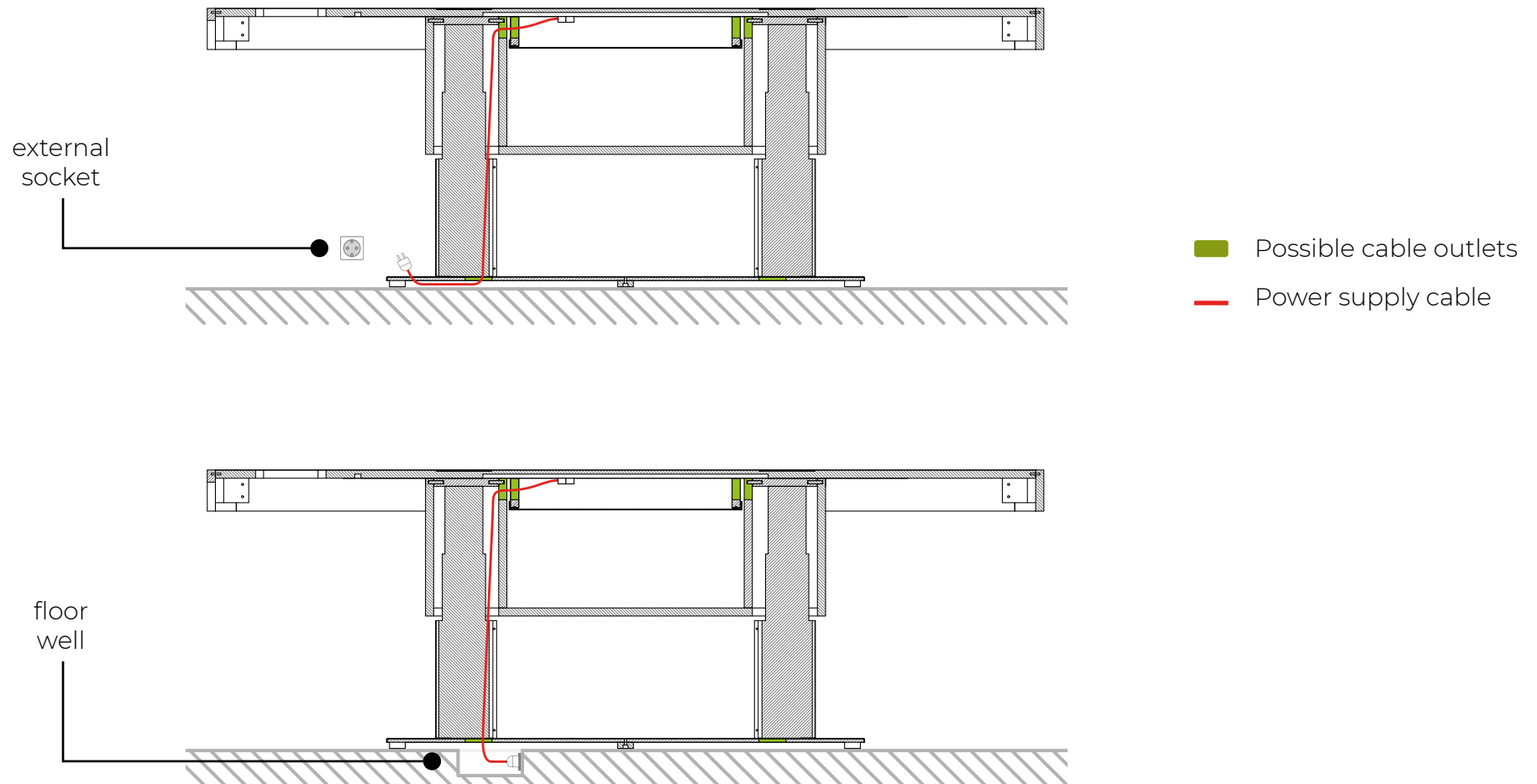
**NOTES**

For assembly, please refer to the Set-Up Manual.

## CLOUD MATTRESS

The mattress features 3 layers of progressively graded foam to provide optimal support during pressure application by the operator and to ensure maximum comfort for the client.

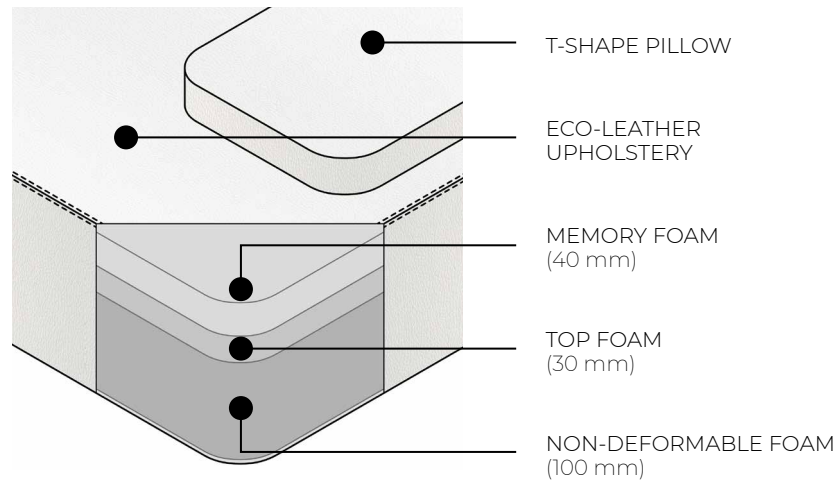

Memory Foam  
always included  
as standard feature



T-shape pillow  
provides extra comfort  
when lying supine



Hand-finished  
stitching

## HERGO SYSTEM

Face hole is designed with a specialised cutout for the forehead. This allows the nose and mouth to rest comfortably in the main opening while the forehead cutout prevents pressure build-up.

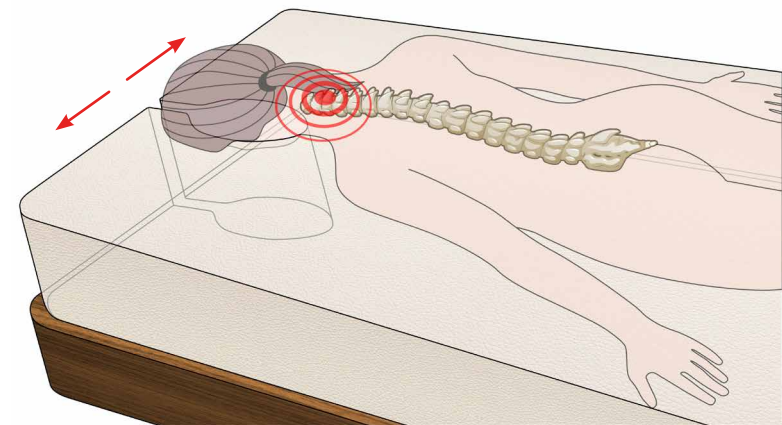

By eliminating pressure on the forehead, this system effectively reduces cervical tension and enhances overall relaxation during treatment.

Bio-technologies mean technologies for life. By integrating them, we transform beds into advanced tools that enhance treatment efficacy while offering significant health benefits. Our goal is to enhance Client experience and promote overall well-being.

Powered by **LIFE WELLTECH**  
bio-technologies for wellness

### REDHEAT (HEATING SYSTEM)

RedHeat employs Far Infrared Rays (FIR), bio-energetic rays with the unique ability to penetrate deeply into the skin layers, enhancing blood circulation, relieving muscle pain, reducing inflammation, detoxifying the body and promoting relaxation.

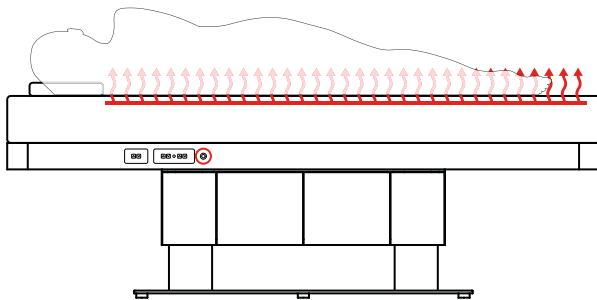
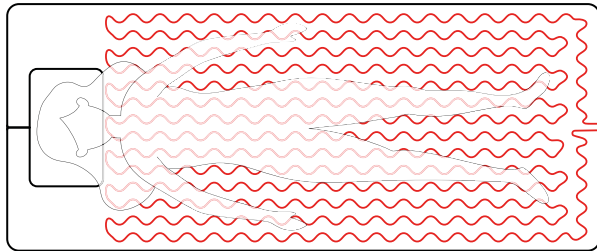

Voltage	24 Vdc
Current at rated load	5 A
Power	120 W

### 360° SOUND EXPERIENCE (SOUND SYSTEM)

This technology generates high-definition sound produced by impulse speakers that create light vibrations, transforming the bed into an instrument itself.

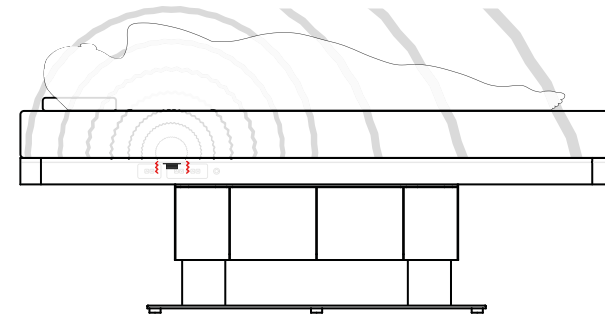
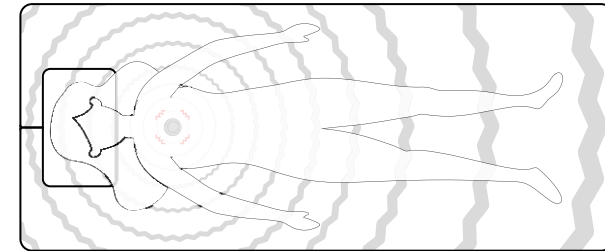

Voltage	24 Vdc
Impedance	4 Ohms
Power	30 W

COATING DECORS (STRUCTURE)



METAL DECORS (BASE)

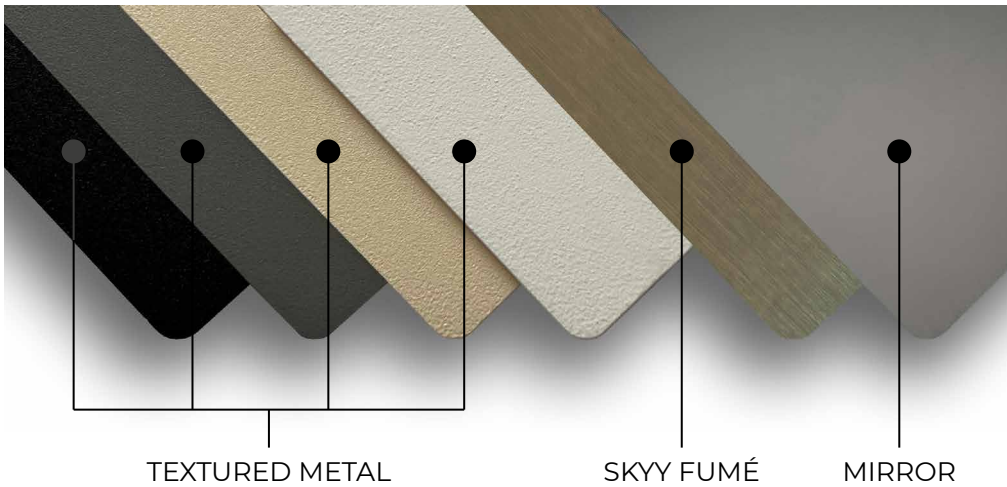

Metal finishes are only available for the bases of models S\_02, S\_03, S\_04 and NUDE.

STANDARD FINISHES

COATING DECORS - WOOD EFFECT



METAL DECORS



PREMIUM FINISHES

COATING DECORS - SOLID COLOURS



COATING DECORS - LEATHER EFFECT



METAL DECORS



STANDARD FINISHES

ECO-LEATHER - UPHOLSTERY



CONFIGURATOR

Play with finishes!  
Visit our website and create your personalised model with our intuitive configurator.



DOWNLOAD  
OUR COMPLETE TEXTURE BROCHURE



## DIFFERENT WIDTHS

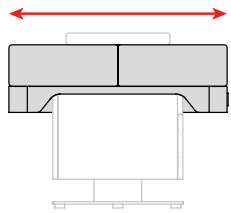

Standard: 840 mm (33")

Optional: 760 mm (29.9")

## ERGONOMIC ARMRESTS

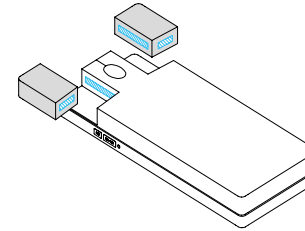

Armrests are integrated into the plateau, providing enhanced stability and allowing a perfect comfort position. Unlike traditional drop-down armrests, our design ensures seamless support and ease of use.

## ERGONOMIC CUT - FEET SIDE

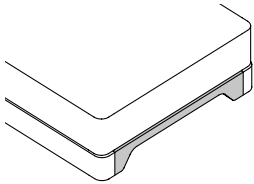

The operator leg cutout on the face side of the plateau can also be requested on the foot side.

## INTERNATIONAL PLUGS

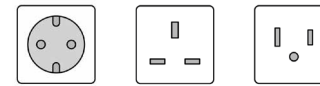

EU (230 V)  
UK (230 V)  
USA (110 V)

## CHROMO LED SYSTEM

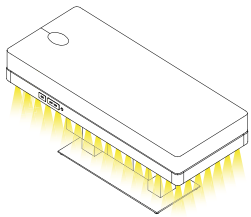

The optional chromo LED system provides lighting to enhance relaxation, energy and body-mind balance.

## EXTERNAL HEAD SUPPORT

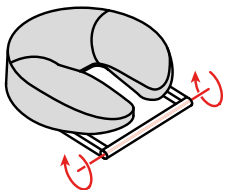

Comfortable external headrest

# BELTRAMI

*designing textile experiences*

MADE IN ITALY

Building on the collaboration started with C.O.D.E., SKYY also partners with Beltrami, a premier manufacturer of luxury linens Made in Italy. Working closely with clients, we can provide top-tier linen products tailored according to your exact requirements, whether it's specific colours, patterns or materials.

Thus we create bespoke bedding solutions that embody the pinnacle of luxury and comfort.



## HEIGHT ADJUSTMENT MOTORS

N° of motors	2
Voltage	24 Vdc
Current at rated load	4 ± 0,7 A each
Frequency	50/60 Hz
Load capacity	2x 2000 N (push)

## BACKREST-LEGREST ADJUSTMENT MOTORS

N° of motors	2
Voltage	24 Vdc
Current at rated load	3 A each
Frequency	50/60 Hz
Load capacity	up to 160 kg (352 Lbs)

## STRUCTURE COATING

Resistance to abrasion	≥ Level 3; IP ≥ 150; WP ≥ 350
Resistance to scratches	≥ Level 3; ≥ 4N
Resistance to steam	≥ Level 4
Resistance to dry heat	≥ Level 4
Resistance to stains	≥ Level 4
Resistance to light	≥ 4 grey scale
Formaldehyde emissions	≤ 3,5 mg/hm <sup>2</sup>
Fire Proof Norms	EN ISO 11925 - 2:2010 Surface flame impingement = 30 s EN ISO 11925 - 2:2010 Edge flame impingement = 30 s EN 13823:2010 Flaming droplets within 600 s not detected

## MATTRESS UPHOLSTERY

Eco-leather PU	
Chemical solvents-free, meets REACH and OEKO-TEX certifications	
High scratch and abrasion resistance	
Durability performance	Abrasion test > 250.000 cycles (heavy use)
Resistance to hydrolysis	10 years
Fire Proof Norms	BS 5852 Part I - Cigarette & Match Tests EN 1021-1 / 2 - Cigarette & Match Tests CA Tech. Bull. 117:2013 / NFPA 260 Cigarette test

## NORMS

All Equipment is CE marked.

All electronic components are CE, CB and UL certified.

Directive 2006/42/CE (Machinery Directive) and national regulations.

Directive 2014/30/UE (Electromagnetic Compatibility Directive) and national regulations.



ISO 9001 sets out the criteria for a quality management system. This standard is based on a number of management principles to help ensure that customers get consistent, good-quality products and services.



ISO 14001 specifies the requirements for an organization seeking to manage its environmental responsibilities in a systematic manner that contributes to the environmental pillar of sustainability.



ISO 16000 is intended to aid the planning of indoor pollution monitoring. A+ label means all standards and recommendations are met in full, with very low emissions into indoor air.



Our upholstery comply with REACH Regulation for the restriction of chemicals, to provide a high level of protection for human health and environment.



Our upholstery comply with STANDARD 100 by OEKO-TEX® as have been tested against a list of up to 350 toxic chemicals to protect your health.



FSC Chain-of-Custody Certification traces the path of products from forests through the supply chain, verifying that any company before the end user must be FSC labelled to promote the products as FSC certified.



Indoor Health and Wellness Certification: With the prestigious “Indoor Air Comfort GOLD” recognition, SKYY commits to uncompromising biocompatibility, promoting a healthier and purer environment.



The Green Key certificate is the leading standard for excellence in the field of environmental responsibility and sustainable operation within the tourism industry.

Made with GREEN care



Carefully selected materials to ensure high bio-compatibility



Integration of bio-technologies, prioritising wellbeing experience



“Indoor Air Comfort GOLD” Certification



Compliant with Green Key Standards



SKYY guarantees a full 2-year warranty on all the electrical components of the product.



SKYY guarantees a full 3-year warranty on mattress, upholstery and foam.



SKYY guarantees a full 5-year warranty on electric actuators.



SKYY guarantees a full 10-year warranty on frames and metal parts.



SKYY provides a lifetime assistance for any problem throughout the entire life of the product.

SKYY  
SIMPLE. SMART. SPA.

[info@skyyspa.com](mailto:info@skyyspa.com)

[www.skyyspa.com](http://www.skyyspa.com)

MADE IN ITALY